

Cergo Operator Desk System

Solid, ergonomic, and configurable.

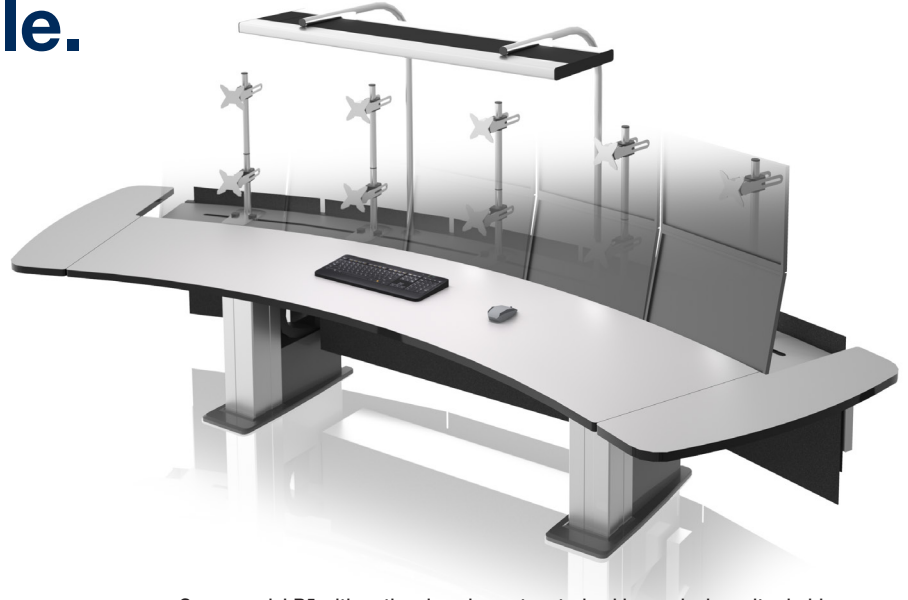

Built to last

Built to last in the toughest 24/7 environments with a solid base in anodized aluminum and steel. The desk and its ergonomic features exceed ISO 11064 & EEMUA 201 recommendations when equipped with the motorized frame. We offer a wide range of accessories that enables upgrades to meet future requirements.

Accessories for every need

With the wide range of accessories you'll find solutions to store computers or personal affects, arrange monitors, reduce noise, increase desk area, integrate non-glare light and personal sound system along with other technical equipment. In the end your customized desk will give you a space efficient solution, easy to clean and maintain.

A model for any design

The CERGO desk system comes in a wide range of sizes and shapes. The solid base allows great flexibility, allowing heavy equipment to be mounted as part of the desk. The desk system is useable for customized designs and to facilitate special equipment.

Design made easy

We have made all models available in CAD, BIM and Sketch up models for ease of use when designing your interior. We can also assist creating your next collaborative environment, please contact us for support.

Cergo model B5 with optional equipment motorized base, dual monitor holders, light unit, sideboards, and noise dampening back panels.

Customize your desk for optimal performance

- Adjustable light, always centered above workplace
- Monitor holder for best alignment of monitors
- Shelf that keeps computers off the floor and reduce cabling problems with height adjustment
- Protective back panels in noise reducing material
- Optional base frame design allows height adjustment of the whole desk or work and monitor board separately

**For details on available accessories,
see the Cergo Accessories Overview.**

Standard desk models

- Load 300kg wide distributed
- With optional motorized base 100-240V 50-60Hz
- Frame and columns in silver RAL 9006
- Level adjustable feet in grey RAL 7015
- High pressure laminate top board:

Formica 7927
Folkstone Light Grey

Formica 7921
Birch

Other colors or specifications are available on request



Sizes

Based on 560 mm wide monitors, for single + dual rows.
The maximum dimensions refers to the optional motorized base.

3 + 3 monitors

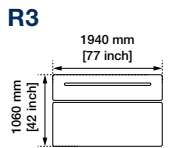
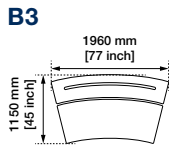

4 + 4 monitors

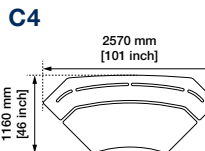
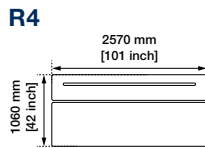
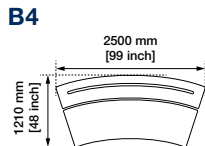

5 + 5 monitors

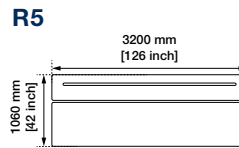
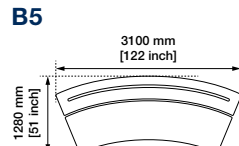

6 monitors

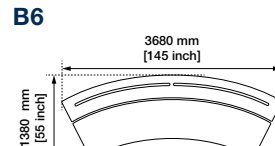

7 monitors

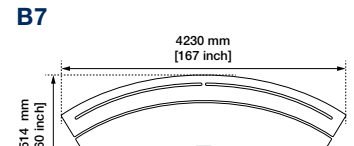

Details

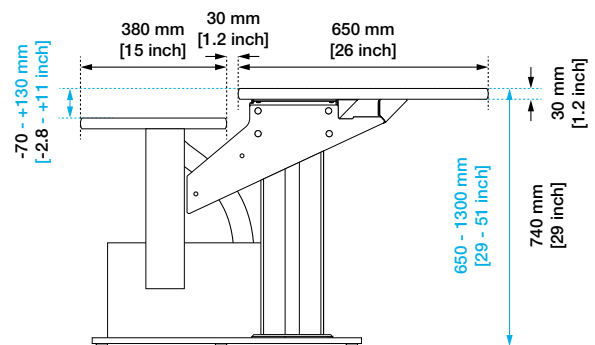
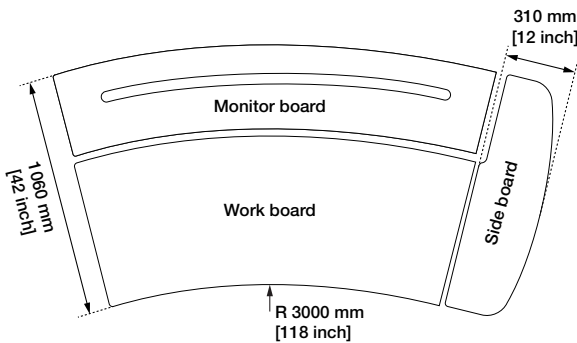

Sideboard available for left and right side on all models

Optional:
Motorized work board enables height adjustments from 650 to 1300 mm
Motorized monitor board enable 200mm lift from base position, 70 mm below work board

CE
The product complies with the essential requirements such as health, safety, function, environmental.

Disclaimer
CGM reserves the right to make changes without further notice to any products to improve reliability, function, or design.
General tolerance for all units ± 20 mm ($\pm 25/32$ inch).
3BSE086569 en A Control Room Solutions Cergo

CGM
Bockasjöгатan 15
SE-504 30 Borås, SWEDEN
Tel.+46 33 22 95 00
www.cgm.se



A MEMBER OF THE ABB GROUP