

Alerto Operator Desk System

Fully featured, sturdy and versatile: Designed to meet the highest human factors demands.

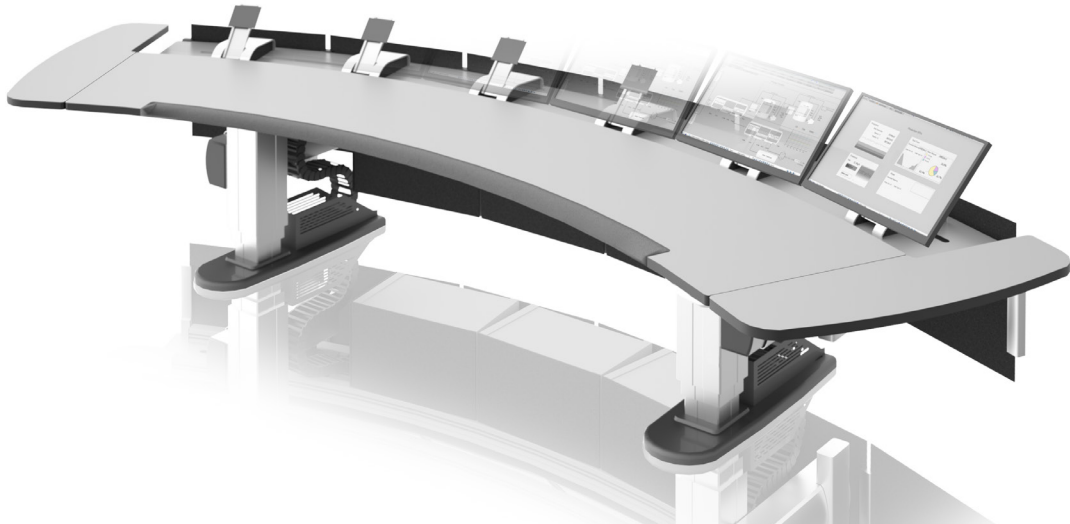

Built to last

Built to last in the toughest 24/7 environments with a sturdy base in anodized aluminum and steel. The desk and its ergonomic features exceeds ISO 11064 & EEMUA 201 recommendations with its motorized frame.

Features for every need

This fully featured desk offers solutions to store computers or personal affects, arrange monitors, reduce noise, increase desk area, along with other technical equipment. In the end your desk will give you a space efficient solution, easy to clean and maintain.

A model for any design

The Alerto desk system comes in a wide arrange of sizes and shapes. The sturdy base allows great flexibility, allowing heavy equipment to be mounted as part of the desk. The desk system is useable for customized designs and to facilitate special equipment.

Design made easy

We have made all models available in CAD, BIM and Sketch up models for ease of use when designing your interior. We can also assist creating your next collaborative environment, please contact us for support.

Alerto model B6 with the motorized working board and monitor board, motorized monitor holders, detachable sideboards, recessed armrest, and noise dampening back panels.

Fully equipped for optimal performance

- Motorized height adjustable desk, with detachable sideboards, and comfortable recessed and replaceable armrest
- Separate motorized monitor board with monitor mounts that enable adjustable monitor angle, height, and depth
- Dedicated hardware shelf that keeps computers of the floor and reduce cabling problems with height adjustment
- Noise reducing back panels which reduces ambient buzz and PC noise

Optimize human performance in 24/7 control environments, and prepare for long-term upgradeability to match new needs and technologies.

Standard desk models

- Load 300kg wide distributed
- Power: 100-240V 50-60Hz
- Frame in silver RAL 9006
- Level adjustable feet in grey RAL 7015
- High pressure laminate top board:

Formica 7927
Folkstone Light Grey

Formica 7921
Birch

Other colors or specifications are available on request

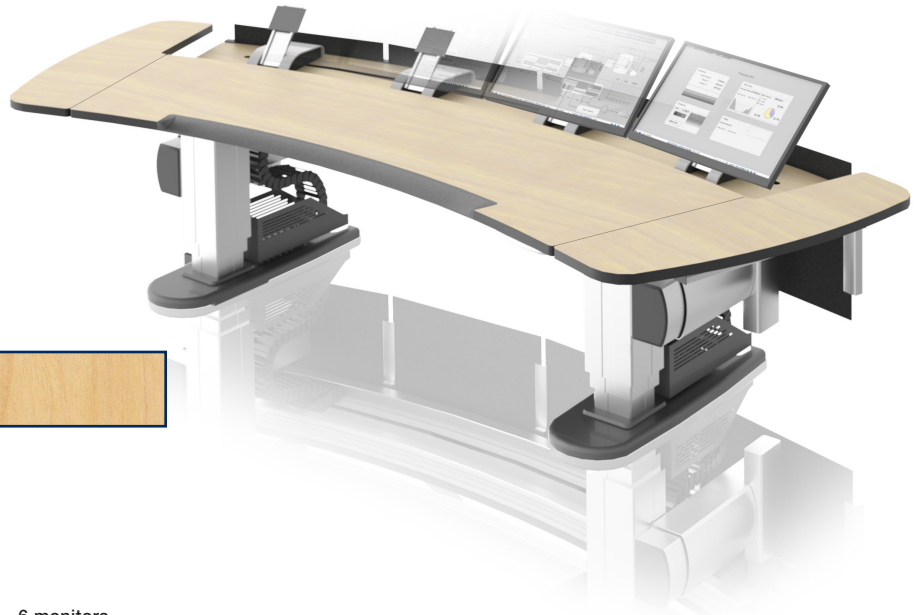

Sizes

Based on 560mm wide monitors.

4 monitors

B4

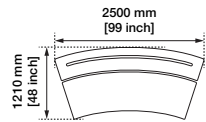

R4

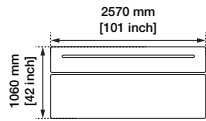

5 monitors

B5

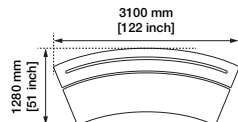

R5

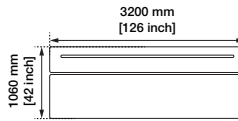

6 monitors

B6

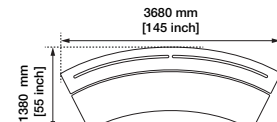

R6

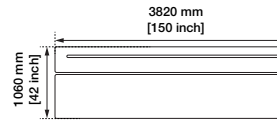

Details

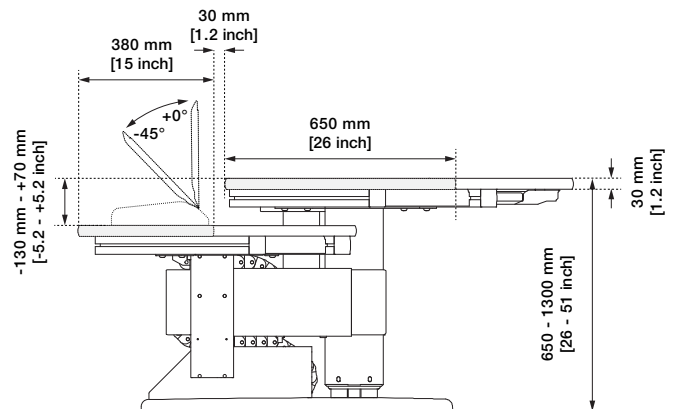
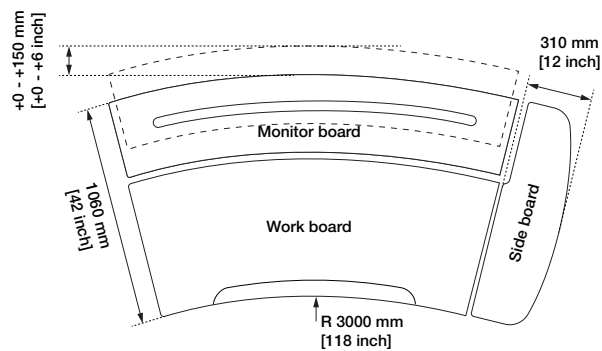

Sideboard included for left and right side on all models

CE CE
The product complies with the essential requirements such as health, safety, function, environmental.

Disclaimer
CGM reserves the right to make changes without further notice to any products to improve reliability, function, or design. General tolerance for all units ± 20 mm ($\pm 25/32$ inch). 3BSE086567 en A Control Room Solutions Alerto

CGM
Bockasjöгатan 15
SE-504 30 Borås, SWEDEN
Tel. +46 33 22 95 00
www.cgm.se



A MEMBER OF THE ABB GROUP